

# Angle Performance on Purion M

Jonathan David and Dennis Kamenitsa

*Axcelis Technologies, Inc., 108 Cherry Hill Dr, Beverly, MA 01915 USA*

**Abstract.** Angle control on medium current implanters is important due to the high angle-sensitivity of typical medium current implants, such as halo implants. On the Purion M, beam-to-wafer angles are controlled in both the horizontal and vertical directions. In the horizontal direction, the beam angle is measured through six narrow slits, and any angle adjustment is made by electrostatically steering the beam, while cross-wafer beam parallelism is adjusted by changing the focus of the electrostatic parallelizing lens (P-lens). In the vertical direction, the beam angle is measured through a high aspect ratio mask, and any angle adjustment is made by slightly tilting the wafer platen prior to implant.

A variety of tests were run to measure the accuracy and repeatability of Purion M's angle control. SIMS profiles of a high energy, channeling sensitive condition show both the cross-wafer angle uniformity, along with the small-angle resolution of the system. Angle repeatability was quantified by running a channeling sensitive implant as a regular monitor over a seven month period and measuring the sheet resistance-to-angle sensitivity. Even though crystal cut error was not controlled for in this case, when attributing all Rs variation to angle changes, the overall angle repeatability was measured as  $0.16^\circ$  ( $1\sigma$ ). A separate angle repeatability test involved running a series of V-curves tests over a four month period using low crystal cut wafers selected from the same boule. The results of this test showed the angle repeatability to be  $<0.1^\circ$  ( $1\sigma$ ).

**Keywords:** Implant Angle Control

**PACS:** 85.40.Ry, 41.85.Qg

## INTRODUCTION

Angle control on medium current implanters is important for a number of reasons. High tilt halo implants are sensitive to implant angle and require precise control [1]. In addition, as medium current implanters extend their energy range, channeling sensitivity increases for the highest energy implants. The Purion M measures and corrects for beam angles in both the horizontal and vertical directions; this paper will describe how, using sensitive channeling conditions, the beam angle was calibrated to Thermave and sheet resistance measurements, and the total angle repeatability was measured.

## HARDWARE

The Purion M is a medium dose, serial implant tool that uses a hybrid scanning system [2]. The beam is scanned electrostatically in the horizontal plane and angles are corrected by a curved acceleration gap to form rays that are parallel to the central, unscanned ions. The wafer is mechanically scanned in the vertical direction along the tilt plane of the implant. The wafer passes through the ribbon-like beam in an iso-centric manner that uniformly doses the entire wafer. Beam angles are measured in the horizontal and vertical planes prior to implant and automatically corrected to ensure the implant is performed at the angles specified in the recipe.

## Horizontal Angle Correction

Horizontal beam angles are measured by a moving profiler behind a mask with six slots as shown in Figure 1. The angle corrections ensure that the six beamlets spanning the width of the wafer are parallel to each other and that the largest angle satisfies the recipe limit of Maximum Horizontal Beam Angle. Corrections are automatically made by steering the beam prior to the scan plates to correct the average angle or adjusting the parallelizing lens voltage, if necessary, to correct parallelism.

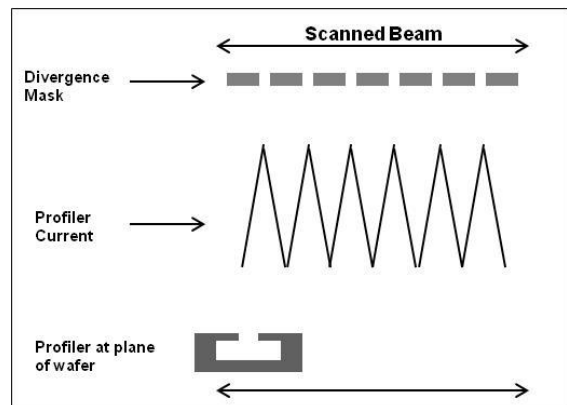
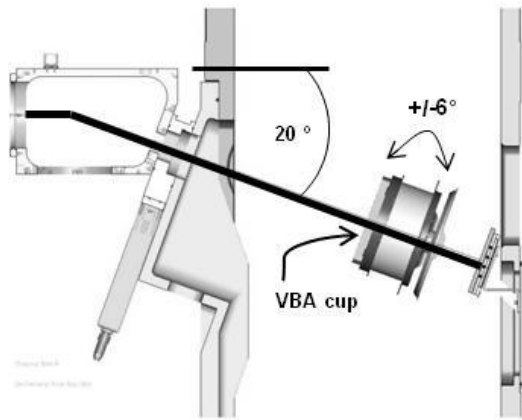

**FIGURE 1.** Schematic of the horizontal beam angle measurement using the six slit mask and profiler.

## Vertical Angle Correction

On the Purion M the ion beam is deflected vertically, by nominally  $20^\circ$ , using an electrostatic energy filter prior to entering the end station. Measurement of the beam angle, orthogonal to the plane of the scanned beam, verifies that the actual Vertical Beam Angle, VBA, of the beam is known prior to implant. The measurement is made by the VBA monitor, which is a faraday with a thick mask with narrow slots that admits more current when it is aligned with the direction of the ions. The VBA monitor is mounted on backside of the wafer platen so that it has a fixed offset from the wafer surface as shown in Figure 2. At the start of a batch, the scan arm tilts so that the VBA monitor collects current as it rotates from  $6^\circ$  above to  $6^\circ$  below the nominal angle, and then again on the way back, to generate two plots of current vs. angle. The two plots are compared to detect noise or beam drop-outs. The flux weighted average angle of the two data sets is the Vertical Beam Angle. This value is then used to correct the mechanical tilt angle of the wafer during implant

Both measurement schemes are calibrated to crystal planes during machine setup to ensure that a  $0^\circ$  implant is normal to the surface of the wafer.



**FIGURE 2.** The scan arm is shown in the position to measure the vertical beam angle. The VBA monitor is mounted to the backside of the wafer platen with a fixed angle to the wafer.

## EXPERIMENT

### Horizontal and Vertical Calibration

The primary goal of this experiment was to evaluate the ability of the angle control scheme of the Purion M to accurately and repeatably measure and correct implant angles from batch to batch over a significant period of time. Prior to running any

repeatability implants, the tool was first aligned in both the vertical and horizontal directions. Vertical alignment entailed running a series of known channeling-sensitive implants of  $P^{++}$  500 keV  $2 \times 10^{13} \text{ cm}^{-2}$  about the  $\langle 100 \rangle$  axial channel (at tilt/twist angles of  $0^\circ/0^\circ$ ) [3,4]. Modifying the mechanical tilt angles to  $\pm 1^\circ$  produced the necessary variation. Figure 3 shows the ThermoWave (TW) result of the vertical angle calibration.

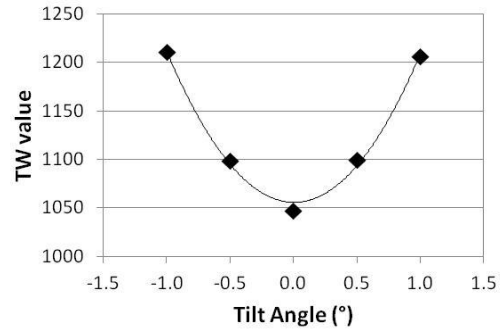

**FIGURE 3.** The average TW values as a function of vertical angle using  $P^{++}$  500 keV  $2 \times 10^{13} \text{ cm}^{-2}$ .

In the horizontal plane on the Purion M, it is not necessary to implant a series of wafers to produce the V-curve of TW vs. angle. One can implant a single wafer with the Parallelizing Lens off so that the scanned beam spans the wafer with angles that vary linearly by  $\pm 4$  degrees at an energy of 60 keV, as shown in Figure 4. By verifying that the minimum TW value coincides with  $0^\circ$  as measured by the horizontal beam angle (HBA) measurement, this ensures that the system is aligned horizontally.

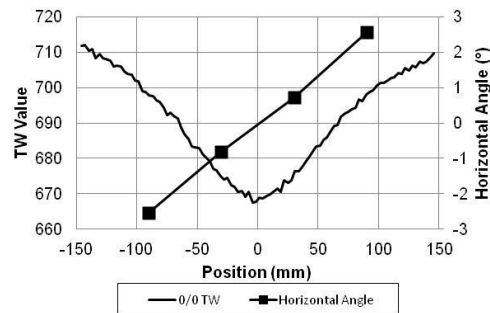
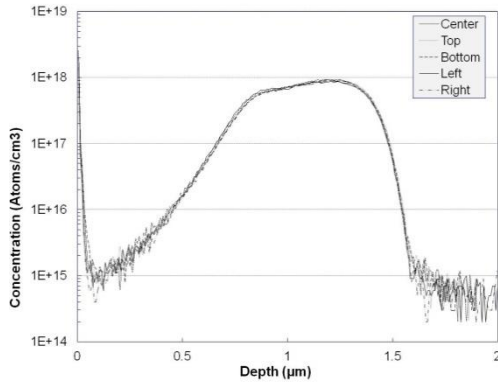

**FIGURE 4.** The horizontal TW variation across a wafer implanted with B+ 60 keV  $2 \times 10^{13} \text{ cm}^{-2}$  run at  $0^\circ$  tilt with the P-lens off. Angles vary linearly from one side to the other.

### SIMS Validation

Once the tool was fully aligned using standard TW techniques, a B+ 335 keV  $5 \times 10^{13} \text{ cm}^{-2}$  implant was run at  $0^\circ$  tilt in order to verify the tool alignment using SIMS. Figure 5 shows the five points SIMS measurements taken at the top, bottom, left, right and

center of the wafer (the notch is at the bottom, the side points are 5 mm from the edge). All five SIMS profiles were well overlaid and showed a prominent channeling peak. This indicates that the Purion M is well aligned to 0° and that both the vertical mechanical scan and horizontal electrostatic scan systems have very good cross-wafer angle uniformity. An additional implant was run a 0.35° tilt to test the small angle resolution of the system. The SIMS profiles shown in Figure 6 demonstrate that the Purion M is able to resolve both 0° and 0.35° tilt implants, and further validates the alignment of the 0° implant to the <100> axial channel.



**FIGURE 5.** SIMS profiles of a B+ 335 keV  $5 \times 10^{13} \text{ cm}^{-2}$  at 0° tilt. Five points on the wafer were measured to show good cross wafer angle uniformity.

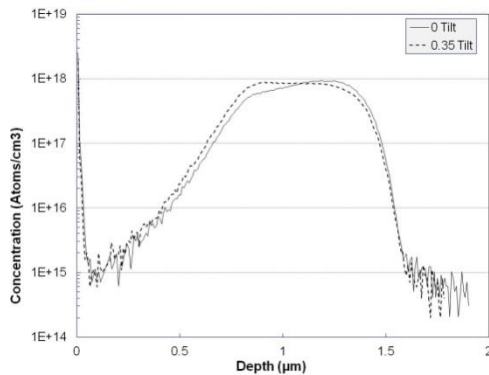
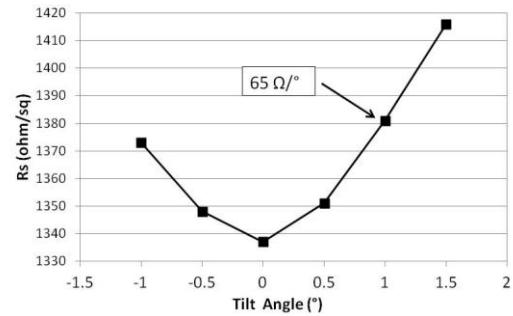

**FIGURE 6.** SIMS profiles of a B+ 335 keV  $5 \times 10^{13} \text{ cm}^{-2}$  at 0° tilt and 0.35° tilt showing good small angle resolution.

### Angle Repeatability Tests

Two separate experiments were run in order to determine the angle repeatability of the Purion M. The first test involved running a B+ 150 keV  $2 \times 10^{13} \text{ cm}^{-2}$  implant at a tilt/twist of 1°/21° on a regular basis over a period of seven months. This implant was chosen based on its high Rs sensitivity to tilt angle variation. As shown in Figure 7, the Rs sensitivity to tilt angle is

65 ohm/sq/degree at 1° tilt, which is greater than the sensitive at 0° tilt and has a more linear response.



**FIGURE 7.** The sheet resistance sensitivity of a B+ 150 keV  $2 \times 10^{13} \text{ cm}^{-2}$  implant. The highest sensitivity occurs at 1° tilt where the curve is more linear.

A total of 57 wafers were run over the seven month time period and were all annealed at 1150°C, 30 seconds, 0.4% O<sub>2</sub>. The Rs data is shown in Figure 8 with dashed lines above and below the data, showing the equivalent change in Rs corresponding to +/- 0.3° in tilt. Of course this type of study has many uncontrolled variables, including processing variations due to the fact that the wafers were annealed and measured at separate times. In addition, this particular test did not control for crystal cut variation from wafer to wafer. That said, if all Rs variation were attributed to tilt angle variation, the overall repeatability would be 0.16° (1σ).

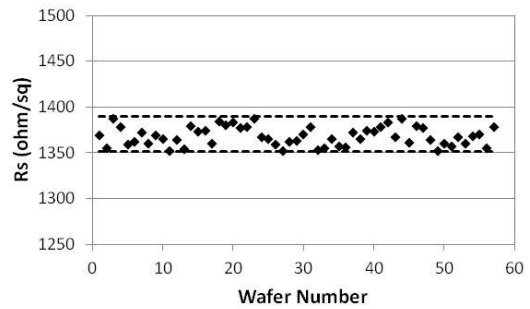
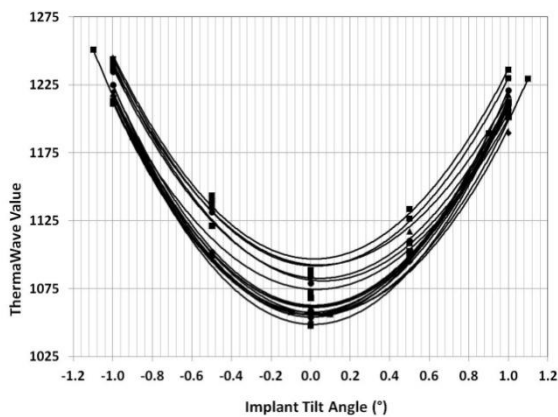

**FIGURE 8.** Sheet resistance results of regular B+ 150 keV  $2 \times 10^{13} \text{ cm}^{-2}$  implants run at tilt/twist of 1°/21°. Upper and lower lines indicate a change in Rs equivalent to +/- 0.3°.

A second, more controlled angle repeatability experiment involved running a series of vertical V-curves over a four month period using the same P<sup>++</sup> 500 keV  $2 \times 10^{13} \text{ cm}^{-2}$  implant condition used for vertical beam angle calibration. In order to control for crystal cut variation, wafers from the same boule, with a known low crystal cut offset, were implanted, measured with ThermoWave and then annealed in order to be re-used for subsequent testing. Although the TW values might vary based on beam current,

wafer temperature, wafer condition, etc., by running three- and five-point V-curves and calculating the TW minimum, it was possible to control for all of those variables.

All of the V-curve data is shown in Figure 9 and the calculated TW minima are shown in Figure 10 as a function of time. Over the four months and 16 data points, the average TW minimum angle was  $0.023^\circ$  and the standard deviation was  $0.019^\circ$  ( $1\sigma$ ) indicating that the Purion M was well calibrated and maintained its alignment over time. It should be noted that the average TW values tended to increase over time as the wafers were continually implanted and annealed, but this did not seem to compromise the V-curve results.



**FIGURE 9.** TW tilt repeatability V-curve results for  $P^{++}$  500 keV  $2 \times 10^{13} \text{ cm}^{-2}$  implants run over a four month period.

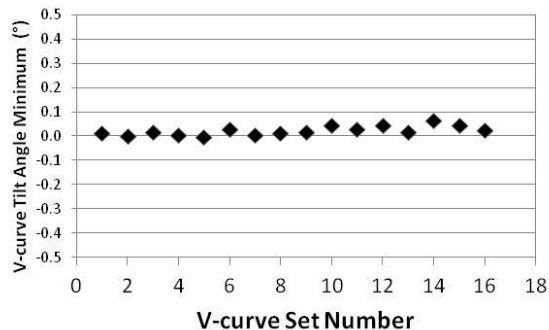

**FIGURE 10.** The wafer implant tilt angle as calculated by V-curve minima of  $P^{++}$  500 keV  $2 \times 10^{13} \text{ cm}^{-2}$  implants. The average angle is  $0.023^\circ$  and the standard deviation is  $0.019^\circ$  ( $1\sigma$ ).

All of these implants were run with vertical beam angle correction enabled, and over the four month test period a number of hardware adjustments to both the scan arm and beamline caused the measured vertical

beam angle to vary by almost a full degree. However, it was never necessary to recalibrate the VBA system, and the tool was able to compensate for any changes in vertical beam setup, and maintain the proper implant angle.

## CONCLUSION

The Purion M has the ability to measure and automatically correct implant angles in the horizontal scan plane and the vertical tilt plane at the start of a batch of wafers. SIMS results show accurate angle setup with good within wafer angle uniformity in all directions. A sensitive channeling implant condition was selected to test the repeatability of the implant angle using Rs measurements, resulting in a total angle repeatability of  $0.16^\circ$  ( $1\sigma$ ) without controlling for crystal cut or processing variations. A well controlled repeated V-curve test using TW measurements on re-used, low crystal cut wafers resulted in an average tilt alignment of  $0.023^\circ$  with an angle repeatability of  $0.019^\circ$  ( $1\sigma$ ).

## ACKNOWLEDGMENTS

The authors would like to thank Fred Silva and Aubrey Chappell for running the implants and all hardware support.

## REFERENCES

- [1] C. Krueger, R. D. Rathmell, D. E. Kamenitsa, and B. Krimbacher, Proc. of Intl. Conf. on Ion Implantation Tech., Monterey, California. 2008 pp. 257-260
- [2] E. Eisner et al., "Purion M: A High Throughput 335keV Mid-Dose Implanter", Proc. of Intl. Conf. on Ion Implantation Tech., Valladolid, Spain, 2012.
- [3] R. D. Rathmell, J. David Proc. of Intl. Conf. on Ion Implantation Tech., Monterey, California. 2008 pp. 148-151
- [4] R. D. Rathmell, D. E. Kamenitsa, M. L. King, and A. M. Ray, IEEE Proc. of Intl. Conf. on Ion Implantation Tech., Kyoto, Japan, 1998, pp. 392-395